



US00D424956S

United States Patent [19]

[11] Patent Number: Des. 424,956

von Buelow et al.

[45] Date of Patent: ** May 16, 2000

[54] ANALYTICAL INSTRUMENT

Primary Examiner—Antoine Duval Davis
Attorney, Agent, or Firm—Oppenheimer Wolff & Donnelly LLP

[75] Inventors: John von Buelow, Oak Park; Barry Sween, Santa Monica, both of Calif.; DeWayne Davis, Lebanon, Ind.

[57] CLAIM

[73] Assignee: Careside, Inc., Culver City, Calif.

The ornamental design for an analytical instrument, as shown and described.

[**] Term: 14 Years

DESCRIPTION

[21] Appl. No.: 29/100,499

FIG. 1 is a front perspective in accordance with a preferred embodiment of the present invention.

[22] Filed: Feb. 11, 1999

FIG. 2 is a front elevation view of the embodiment illustrated in FIG. 1.

[51] LOC (7) Cl. 10-04

FIG. 3 is a back elevation view of the embodiment illustrated in FIG. 1.

[52] U.S. Cl. D10/81

FIG. 4 is a left elevation view of the embodiment illustrated in FIG. 1.

[58] Field of Search D10/81; D24/186, D24/234; 422/56, 58, 61, 102, 49, 43, 46, 100, 63-68; 436/65, 178, 906, 910, 43, 48

FIG. 5 is a right elevation view of the embodiment illustrated in FIG. 1.

[56] References Cited

FIG. 6 is a top elevation view of the embodiment illustrated in FIG. 1; and,

U.S. PATENT DOCUMENTS

FIG. 7 is a bottom elevation view of the embodiment illustrated in FIG. 1.

- D. 340,769 10/1993 Bloom et al. D24/234 X
- D. 381,749 7/1997 Lawrence et al. D24/234 X

1 Claim, 7 Drawing Sheets

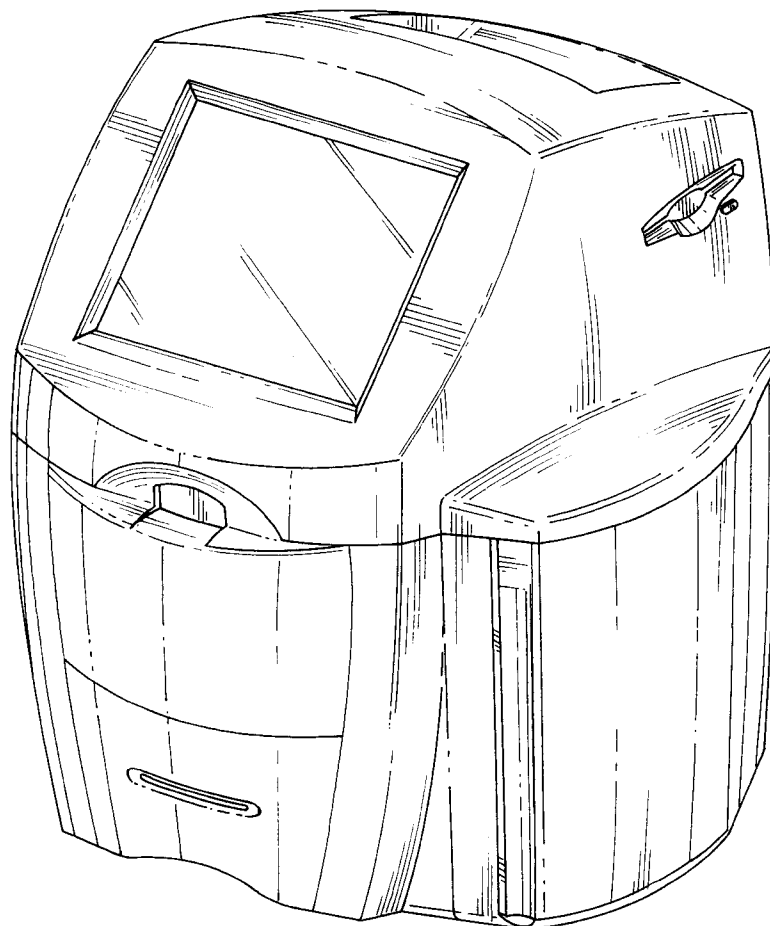

FIG. 1

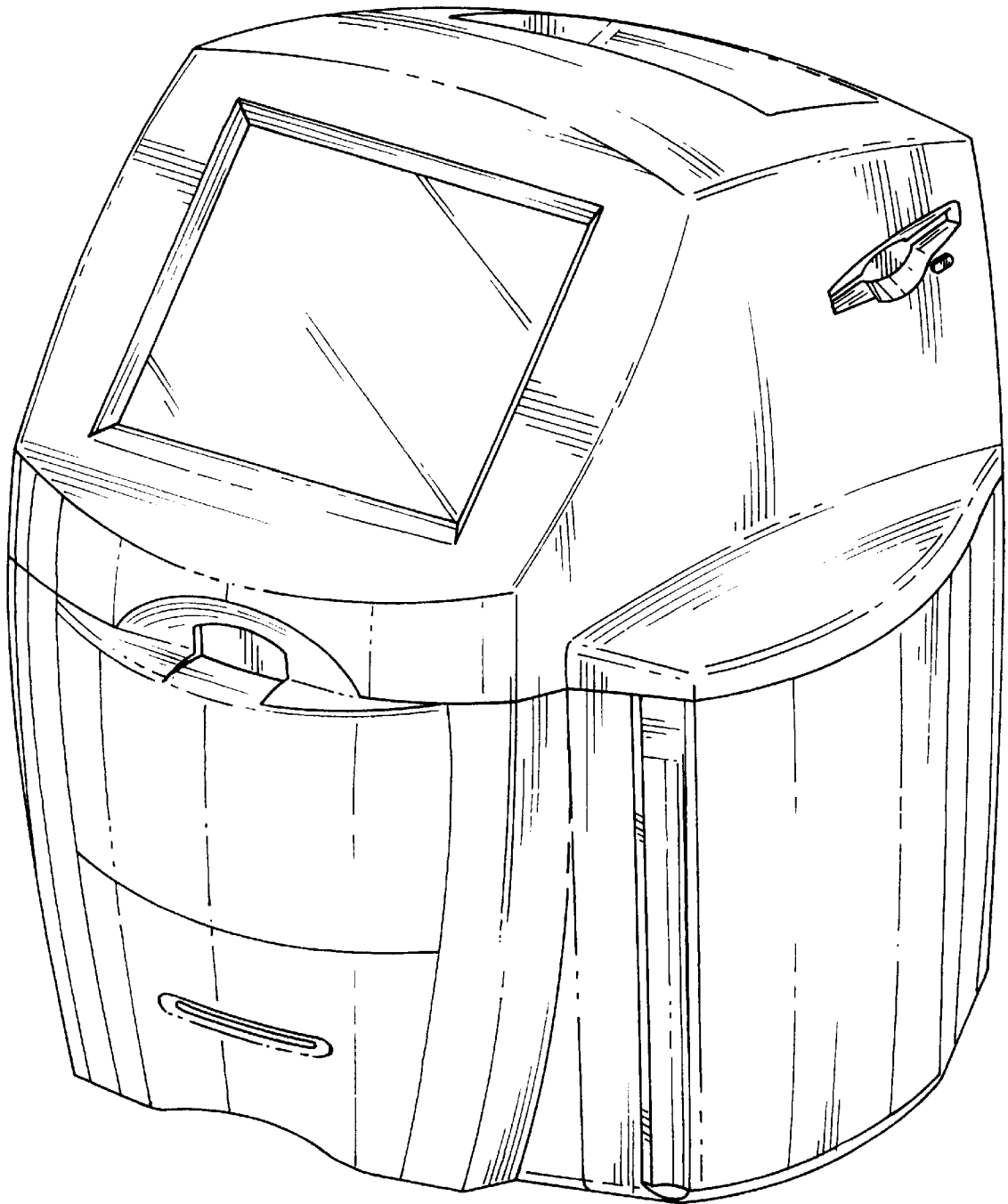

FIG. 2

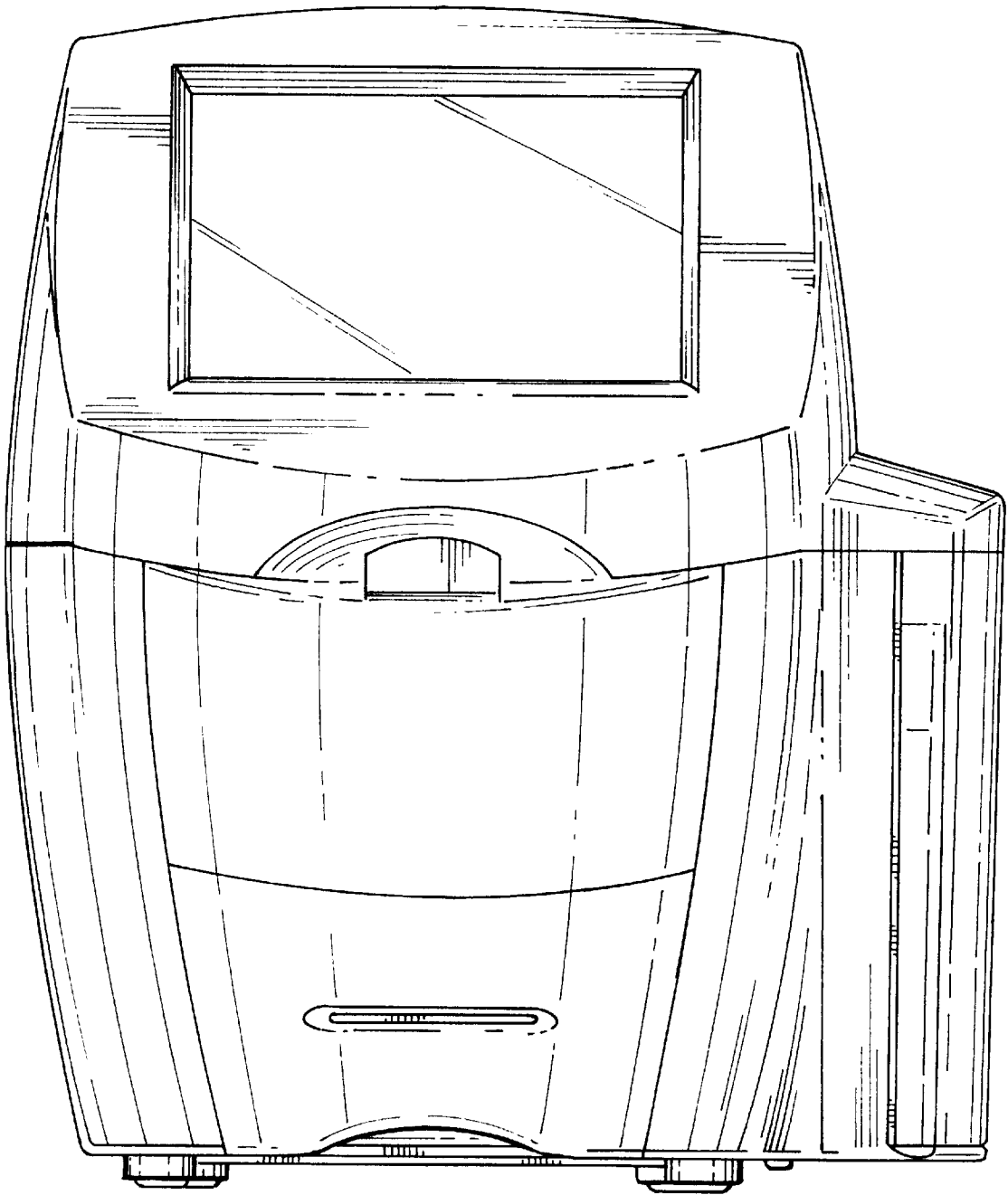

FIG. 3

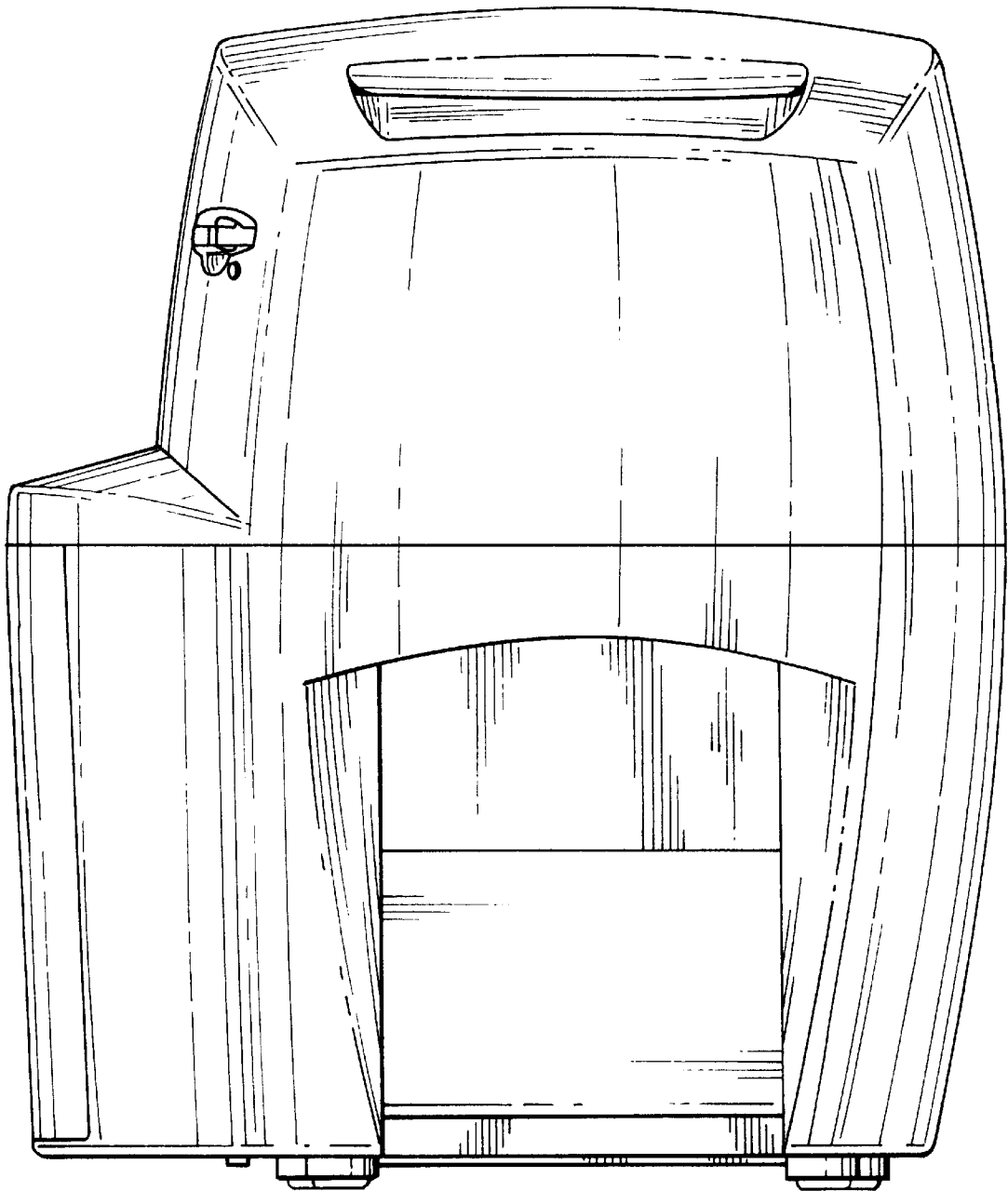

FIG. 4

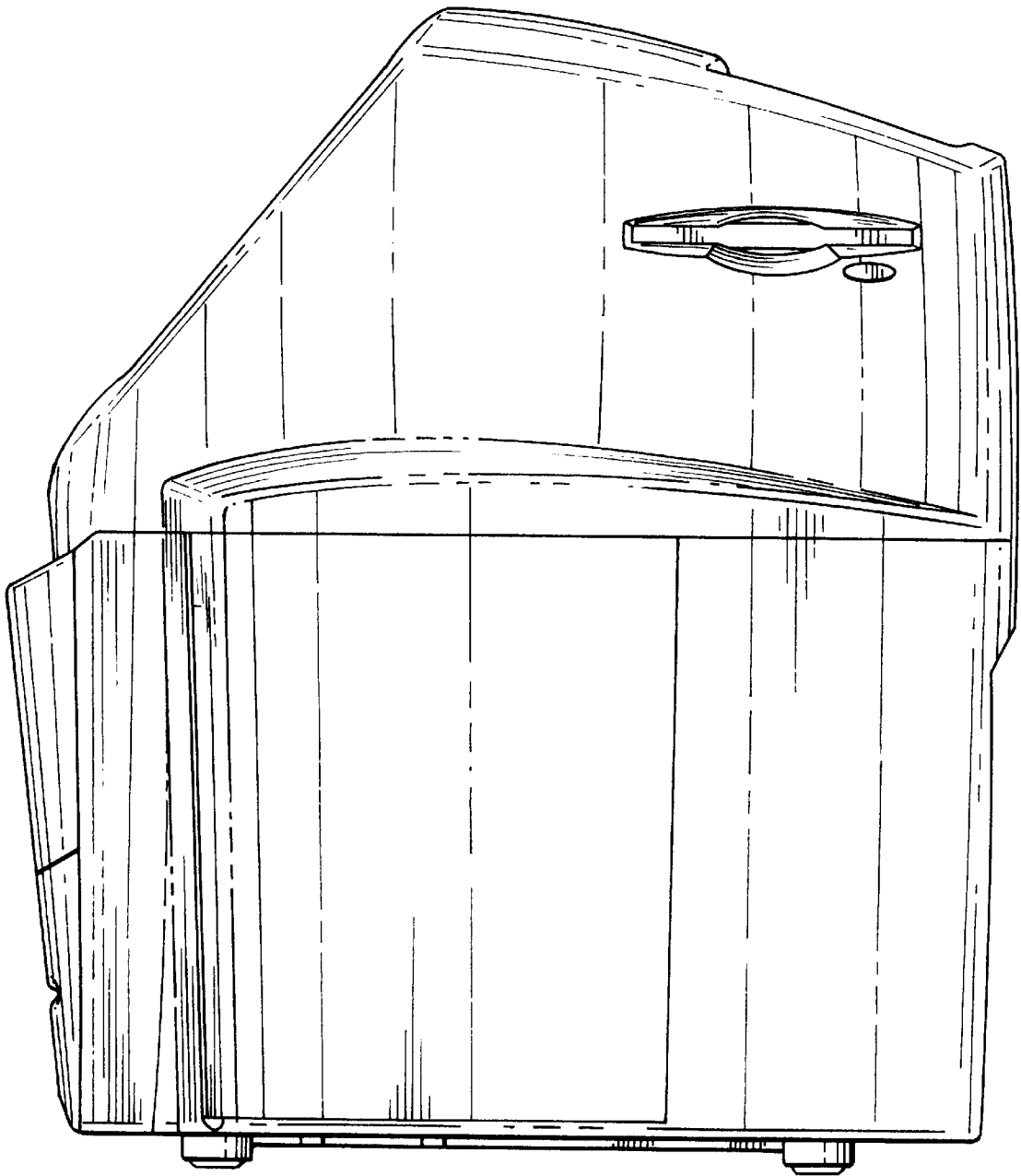

FIG. 5

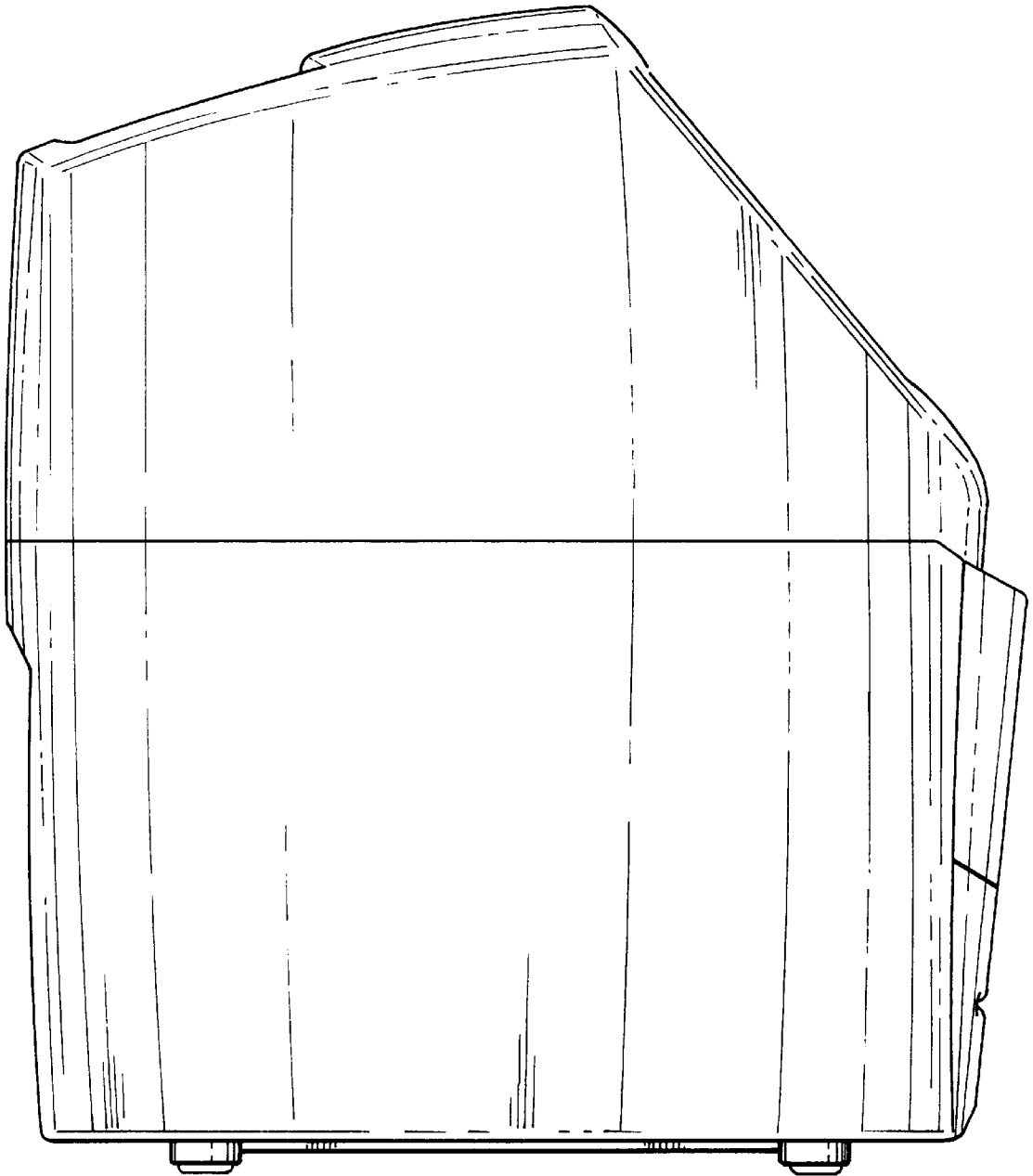

FIG. 6

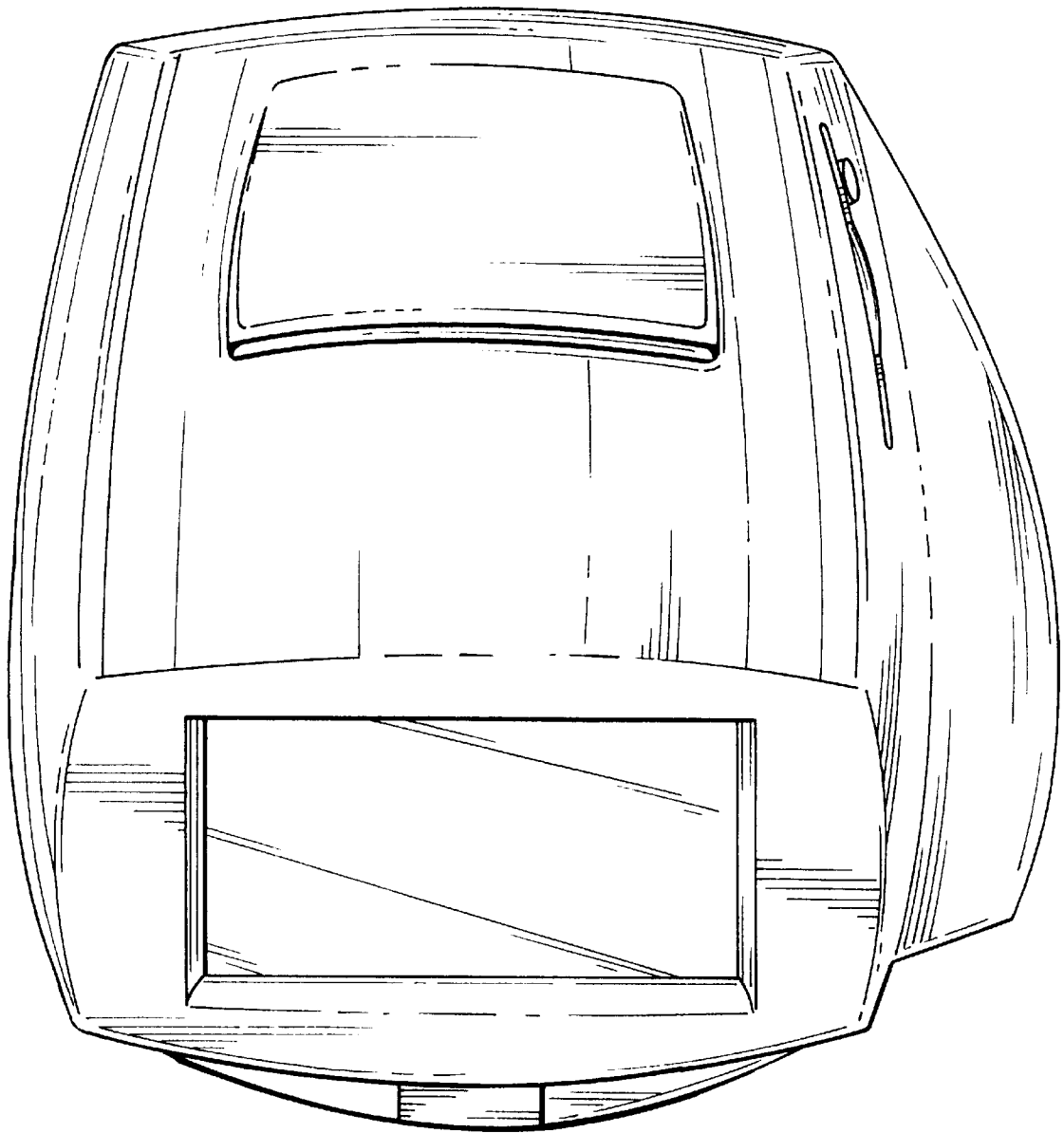

FIG. 7

